



DOC022.53.80022

CDC401

05/2021, Edition 4

User Manual

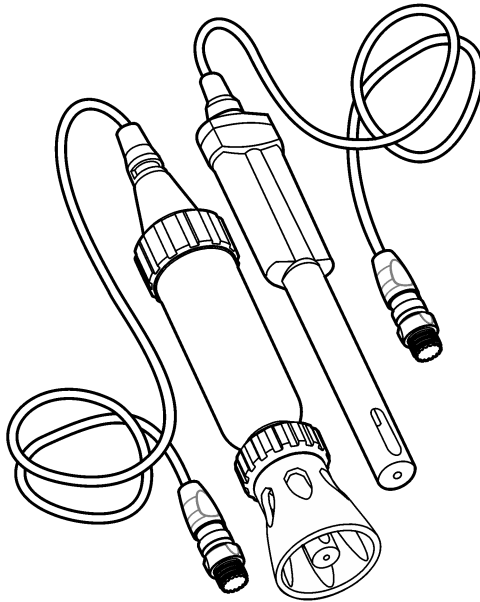

Section 1 Product overview	3
Section 2 Specifications	3
Section 3 Safety information	4
3.1 Intended use	4
3.2 Use of hazard information	4
3.3 Precautionary labels	5
3.4 Product hazards	5
Section 4 Preparation for use	5
Section 5 Calibration	5
5.1 Calibration notes	5
5.2 Calibration procedure	6
Section 6 Sample measurement	6
6.1 Sample measurement notes	6
6.2 Sample measurement procedure	7
Section 7 Verify the calibration	7
7.1 Verification procedure	8
Section 8 Maintenance	8
8.1 Clean the probe	8
8.2 Remove or install the shroud	9
8.3 Storage	10
Section 9 Troubleshooting	10
Section 10 Consumables	11

Section 1 Product overview

The Intellical CDC401 series conductivity probes are digital electrodes that measure the electrical conductivity, salinity, resistivity or total dissolved solids (TDS) of wastewater, drinking water and general water samples. The probes have a graphite, 4-pole conductivity cell and a temperature sensor. The standard probes are for laboratory use. The rugged probes are for field use. Refer to [Figure 1](#).

Figure 1 Probe overview

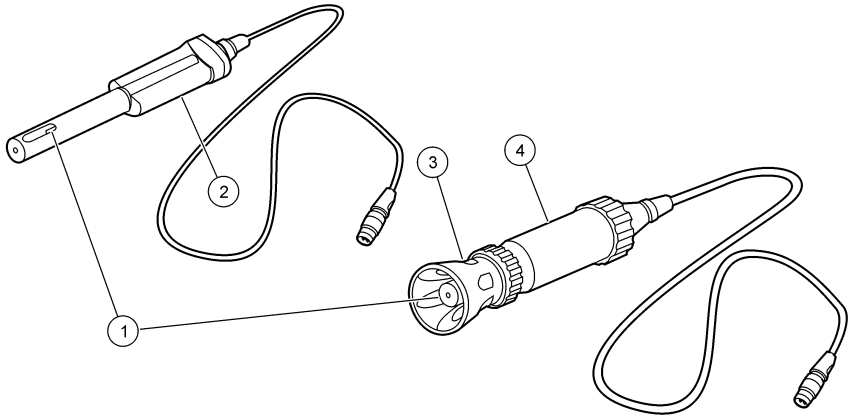

1 Temperature sensor and conductivity cell	3 Shroud (rugged model)
2 Standard probe	4 Rugged probe

Section 2 Specifications

Specifications are subject to change without notice.

Specifications	Details
Probe type	Graphite, 4-pole conductivity probe
Conductivity range	0.01 $\mu\text{S/cm}$ to 200.0 mS/cm
Cell constant	0.40 $\text{cm}^{-1} \pm 10\%$
Conductivity resolution	0.0 to 19.99 $\mu\text{S/cm}$: 0.01 $\mu\text{S/cm}$ 20.0 to 199.9 $\mu\text{S/cm}$: 0.1 $\mu\text{S/cm}$ 200 to 1999 $\mu\text{S/cm}$: 1 $\mu\text{S/cm}$ 2.00 to 19.99 mS/cm: 0.01 mS/cm 20.0 to 200.0 mS/cm: 0.1 mS/cm
Conductivity accuracy	$\pm 0.5\%$ of reading
TDS (total dissolved solids) range	0 to 50,000 mg/L as NaCl
TDS resolution	0.0 to 19.99 mg/L: 0.01 mg/L 200 to 1999 mg/L: 1 mg/L 2.00 to 19.99 g/L: 0.01 g/L 20.0 to 50.0 g/L: 0.1 g/L

Specifications	Details
TDS accuracy	±0.5% of reading
Sample salinity range	0 to 42 (ppt) (‰)
Salinity resolution	0.01 parts per thousand (ppt) (‰)
Salinity accuracy	±1 parts per thousand (ppt) (‰)
Temperature accuracy	±0.3 °C (±0.54 °F)
Operating temperature	–10 to 110 °C (14 to 230 °F)
Storage temperature	5 to 40 °C (41 to 104 °F)
Minimum immersion depth	45 mm (1.77 in.)
Body material (standard)	Noryl
Cable connection	M12 digital output and connector
Dimensions	Diameter: 15 mm (0.59 in.) Length: 174 mm (6.9 in.) total; 90 mm (3.5 in.) below head Cable length: CDC40101: 1 m (3.3 ft); CDC40103: 3 m (9.8 ft)
Dimensions (rugged)	Diameter: 46 mm (1.8 in.) Length: 223 mm (8.7 in.) Cable length: CDC40105: 5 m (16.4 ft); CDC40110: 10 m (32.8 ft); CDC40115: 15 m (49.2 ft); CDC40130: 30 m (98.4 ft)
Warranty	1 year on the probe. This warranty covers manufacturing defects, but not improper use or wear.
Certifications	CE, FCC/ISED

Section 3 Safety information

3.1 Intended use

The Intellical probes are intended for use by individuals who measure water quality parameters in the laboratory or in the field. The Intellical probes do not treat or alter water.

3.2 Use of hazard information

▲ DANGER

Indicates a potentially or imminently hazardous situation which, if not avoided, will result in death or serious injury.

▲ WARNING

Indicates a potentially or imminently hazardous situation which, if not avoided, could result in death or serious injury.

▲ CAUTION

Indicates a potentially hazardous situation that may result in minor or moderate injury.

NOTICE



Indicates a situation which, if not avoided, may cause damage to the instrument. Information that requires special emphasis.

3.3 Precautionary labels

Read all labels and tags attached to the instrument. Personal injury or damage to the instrument could occur if not observed. A symbol on the instrument is referenced in the manual with a precautionary statement.

	Electrical equipment marked with this symbol may not be disposed of in European domestic or public disposal systems. Return old or end-of-life equipment to the manufacturer for disposal at no charge to the user.
--	---

3.4 Product hazards

▲ CAUTION	
	Chemical exposure hazard. Obey laboratory safety procedures and wear all of the personal protective equipment appropriate to the chemicals that are handled. Refer to the current safety data sheets (MSDS/SDS) for safety protocols.
▲ CAUTION	
	Chemical exposure hazard. Dispose of chemicals and wastes in accordance with local, regional and national regulations.

Section 4 Preparation for use

Prepare the probe as follows.

1. Rinse the probe with deionized water. Blot dry with a lint-free cloth.
2. Make sure that the meter has the correct date and time settings. The service-life time stamp in the probe comes from the date and time settings in the meter.

Note: Some meters automatically open the date and time settings when the meter starts for the first time, or after battery replacement.

3. Connect the probe to the meter.

Section 5 Calibration

The procedure that follows is applicable to meters that can connect to Intellical conductivity probes. Refer to the applicable meter documentation for meter operation and probe-specific settings.

5.1 Calibration notes

Read the notes that follow before calibration.

- Do not dilute conductivity standards or samples.
- The meter shows the conductivity standard solution to use for calibration. If necessary, change the standard solution in the probe settings menu.
- The conductivity value changes with temperature. The default probe settings apply a temperature correction to adjust the conductivity measurements to the value at 25 °C.
- Use the default calibration options or change the options in the probe settings menu.
- Use the single display mode for calibration when more than one probe is connected to the meter (if applicable).
- Calibrate the probes and verify the calibration regularly for best results. Use the meter to set calibration reminders.
- The calibration data is stored in the probe. When a calibrated probe is connected to a different meter with the same calibration options, a new calibration is not necessary.

- Air bubbles below the sensor when in solution can cause a slow response or error in the calibration. Make sure to remove air bubbles during calibration.
- If the rugged probe does not easily go in the calibration container, remove the shroud. Refer to [Remove or install the shroud](#) on page 9.

5.2 Calibration procedure

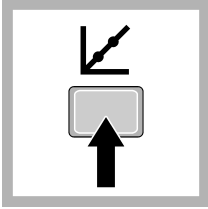

1. Go to the calibrate menu. Select the probe, if applicable. The display shows the conductivity standard solution to use for calibration.

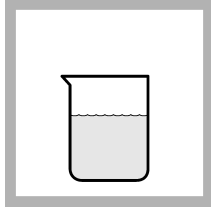

2. Pour the fresh standard solution into a beaker.

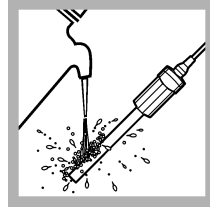

3. Rinse the probe with deionized water. Dry the probe with a lint-free cloth.

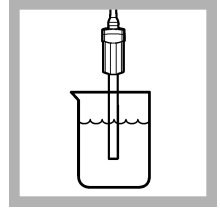

4. Put the probe in the standard solution with the sensor fully in the solution. Do not put the probe on the bottom or sides of the beaker.

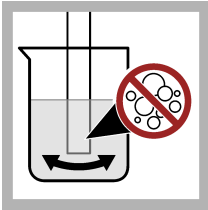

5. Shake the probe from side to side to remove air bubbles.

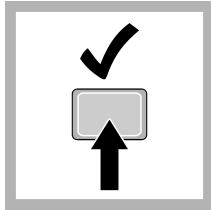

6. Stir gently, then read the conductivity value of the standard solution. The display shows the temperature-corrected conductivity value when the reading is stable.

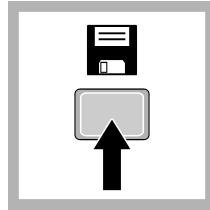

7. Save the calibration.

Section 6 Sample measurement

The procedure that follows is applicable to meters that can connect to Intellical conductivity probes. Refer to the applicable meter documentation for meter operation and probe-specific settings.

6.1 Sample measurement notes

Read the notes that follow before sample measurements.

- Rinse the probe with deionized water and dry with a lint-free cloth between measurements to prevent contamination.
- If complete traceability is necessary, enter a sample ID and operator ID before measurement. Refer to the meter manual for instructions.

- The meter can show the measured value as conductivity, TDS (total dissolved solids), salinity or resistivity. Use the probe settings menu to change the parameter.
- If the probe is used to measure the salinity value for dissolved oxygen measurements, change the parameter to salinity.
- The conductivity value changes with temperature. The default probe settings apply a temperature correction to adjust the conductivity measurements to the value at 25 °C.
- The meter automatically saves the measurement data when the user manually reads each data point and when the meter is set to read at regular intervals. The user must manually save each data point when the meter is set to read continuously.
- Air bubbles below the sensor can cause a slow response or error in the measurement. Make sure to remove air bubbles before and during measurements.
- If the probe is a rugged type, make sure to install the shroud before field use to prevent damage to the sensing elements. Refer to [Remove or install the shroud](#) on page 9. The probe warranty does not include such damage.
- To deploy a rugged probe at a distance, toss the probe body with a slow underhand throw. Do not throw the probe by the cable to prevent damage to cable, the probe or the user.

6.2 Sample measurement procedure



1. Rinse the probe with deionized water. Dry the probe with a lint-free cloth.
Rugged probes: install the shroud.

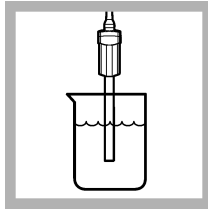

2. Put the probe in the sample with the sensor fully in the sample. Do not put the probe on the bottom or sides of the beaker.

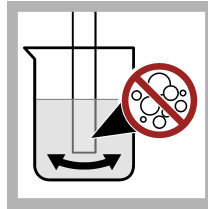

3. Shake the probe from side to side to remove air bubbles.
Rugged probes: move the probe up and down to remove air bubbles.

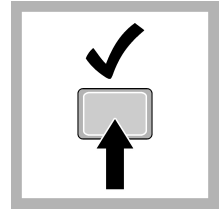

4. Stir gently, then read the conductivity (or TDS, salinity, resistivity) value of the sample. The display shows the temperature-corrected value when the reading is stable.

Section 7 Verify the calibration

Measure the value of a fresh conductivity standard solution to make sure the result is accurate. The meter compares the selected standard solution value to the measured value and accepts or rejects the measurement. The user can change the standard solution and acceptance criteria for verification in the probe-specific settings.

Note: Password protection may prevent access to the acceptance criteria.

7.1 Verification procedure

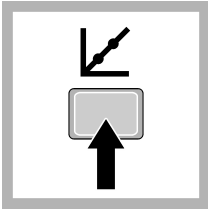

1. Go to the verification menu. The display shows the standard solution to use for verification.

Note: Menu name for HQd meters: Run check standard.

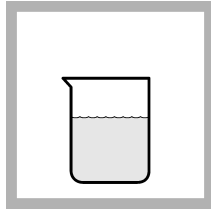

2. Pour the fresh standard solution into a beaker.

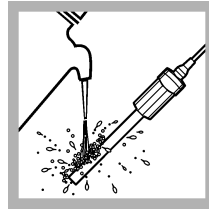

3. Rinse the probe with deionized water. Dry the probe with a lint-free cloth.

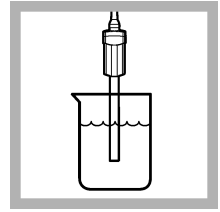

4. Put the probe in the standard solution with the sensor fully in the solution. Do not put the probe on the bottom or sides of the beaker.

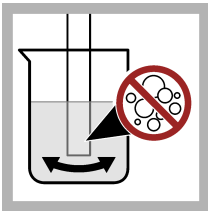

5. Shake the probe from side to side to remove air bubbles.

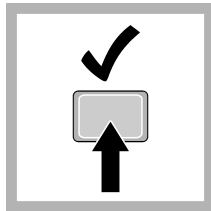

6. Stir gently, then read the conductivity value of the standard solution. The meter accepts or rejects the result.

Section 8 Maintenance

8.1 Clean the probe

Clean the probe regularly to remove mineral or sample buildup on the electrodes. Symptoms of contamination:

- Incorrect or irregular readings
- Slow stabilization times
- Calibration errors
- Sample material stays on the probe

1. Rinse the probe with deionized water. Dry the probe body with a lint-free cloth.

Note: Remove the shroud on a rugged probe before cleaning. Install the shroud after the probe is clean. Refer to [Remove or install the shroud](#) on page 9.

2. Soak the probe in the applicable cleaning solution for the specified time. Refer to [Table 1](#).

3. Rinse or soak the probe for 1 minute in deionized water. Dry the probe body with a lint-free cloth.

Table 1 Cleaning solution

Contamination	Cleaning solution	Active component	Soak time
General contamination	Electrode cleaning solution for regular maintenance	KATHON™ CG, DECONEX®11	12–16 hours
Minerals	Electrode cleaning solution for minerals/inorganic contamination	Phosphoric acid (~10%)	10–15 minutes
Fats, grease and oils	Electrode cleaning solution for fats, oils and grease contamination	KATHON™ CG, TRITON® X	2 hours maximum
Proteins	Electrode cleaning solution for proteins/organic contamination	Pepsin in HCl	3 hours maximum
Wastewater and organic compounds	Electrode cleaning solution, extra strong	Sodium hypochlorite	5–10 minutes

8.2 Remove or install the shroud

Remove the shroud on the rugged probe during calibration and maintenance. Refer to [Figure 2](#). Keep the shroud installed on the rugged probe during sample measurements to prevent damage to the sensor. Refer to [Figure 3](#).

Figure 2 Remove the shroud

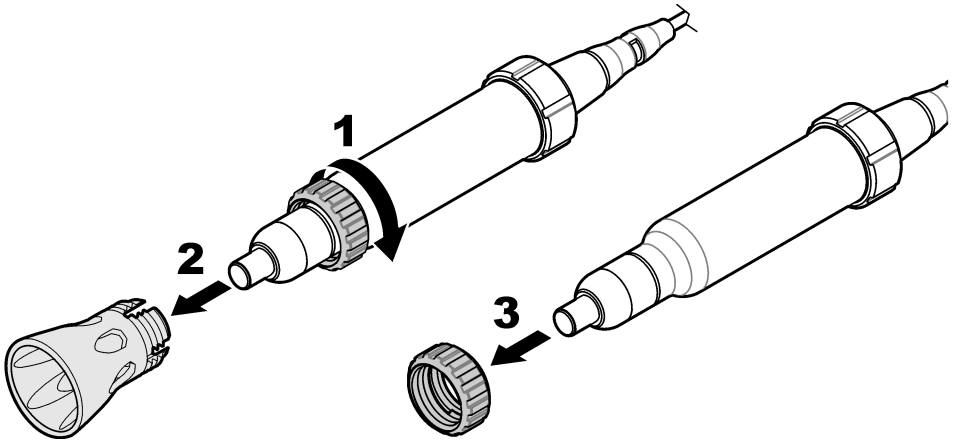
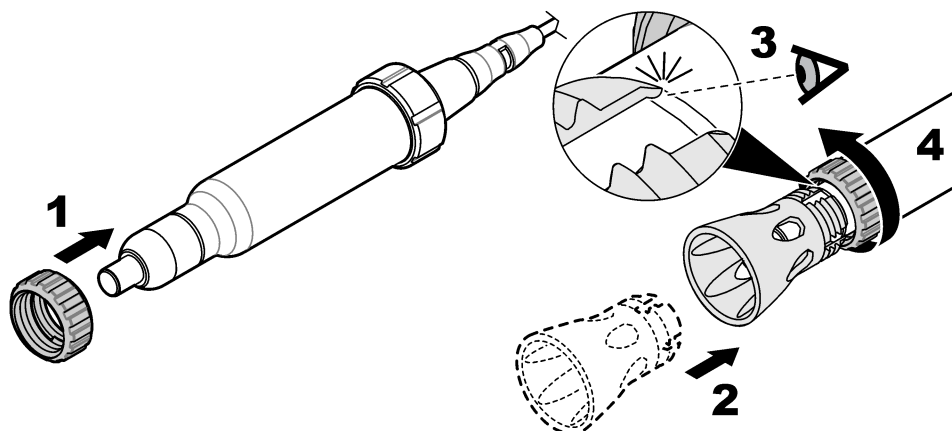

Figure 3 Install the shroud



8.3 Storage

Between uses, make sure the probe is dry and store it in ambient conditions. Rugged probes may be stored with the shroud installed if the storage container is sufficiently large.

Section 9 Troubleshooting

Problem	Possible cause	Solution
Decreased probe performance causes slow stabilization and prevents accurate calibrations or measurements.	The probe has mineral or sample buildup on the electrodes.	Clean the probe. Refer to Clean the probe on page 8.
Sample properties cause slow stabilization or inaccurate measurements.	The sample absorbs carbon dioxide (CO ₂) from the air, which forms carbonic acid and slowly increases the conductivity in low ionic strength (LIS) or high purity samples.	Use the LIS chamber for LIS/high purity samples to prevent CO ₂ absorption.
Procedure problem causes slow stabilization and prevents accurate calibrations or measurements.	An incorrect standard solution was used or the standard solution is contaminated.	Use the specified standard solution of good quality.
	Air bubbles are around or below the probe tip.	Carefully tap or shake the probe to remove air bubbles.
	The conductivity settings in the meter are not correct.	Make sure that the settings for temperature correction, reference temperature and stability are correct.

Section 10 Consumables

Note: Product and Article numbers may vary for some selling regions. Contact the appropriate distributor or refer to the company website for contact information.

Description	Quantity	Item no.
Electrode cleaning solution for regular maintenance	500 mL	2965249
Electrode cleaning solution for minerals/inorganic contamination	500 mL	2975149
Electrode cleaning solution for proteins/organic contamination	250 mL	C20C370
Electrode cleaning solution for fats, oils and grease contamination	500 mL	2964449
Electrode cleaning solution, extra strong	250 mL	S16M002
Conductivity standard solution (KCl), 147 $\mu\text{S}/\text{cm}$, Singlet one-use packets, 20 mL each	20/pkg	2771320
Conductivity standard solution (KCl), 1413 $\mu\text{S}/\text{cm}$, Singlet one-use packets, 20 mL each	20/pkg	2771420
Conductivity standard solution (KCl), 12.88 mS/cm , Singlet one-use packets, 20 mL each	20/pkg	2771520
Sodium chloride standard solution, 180 (± 10) $\mu\text{S}/\text{cm}$, 90 (± 1) mg/L TDS	100 mL	2307542
Sodium chloride standard solution, 1000 (± 10) $\mu\text{S}/\text{cm}$, 500 (± 5) mg/L TDS	100 mL	1440042
Sodium chloride standard solution, 1990 (± 20) $\mu\text{S}/\text{cm}$, 995 (± 10) mg/L TDS	100 mL	210542
Sodium chloride standard solution, 18,000 (± 50) $\mu\text{S}/\text{cm}$, 9000 (± 25) mg/L TDS	100 mL	2307442
Wash bottle, polyethylene, 500 mL	1	62011
Disposable wipes, 11 x 22 cm	280/pkg	2097000
Beaker, 30 mL, plastic, colorless	80/pkg	SM5010
Beaker, 100 mL, polypropylene	1	108042
Probe cable depth markers for rugged Intellical probes	5/pkg	5828610
Probe stand for standard Intellical probes	1	8508850
Shroud kit for rugged probes	1	5825900



HACH COMPANY World Headquarters

P.O. Box 389, Loveland, CO 80539-0389 U.S.A.
Tel. (970) 669-3050
(800) 227-4224 (U.S.A. only)
Fax (970) 669-2932
orders@hach.com
www.hach.com

HACH LANGE GMBH

Willstätterstraße 11
D-40549 Düsseldorf, Germany
Tel. +49 (0) 2 11 52 88-320
Fax +49 (0) 2 11 52 88-210
info-de@hach.com
www.de.hach.com

HACH LANGE Sàrl

6, route de Compois
1222 Vézenaz
SWITZERLAND
Tel. +41 22 594 6400
Fax +41 22 594 6499